

# Дюбели рамкови,к-кт с болт патентен

## FUR 10 x 80 SS K NV, блистер

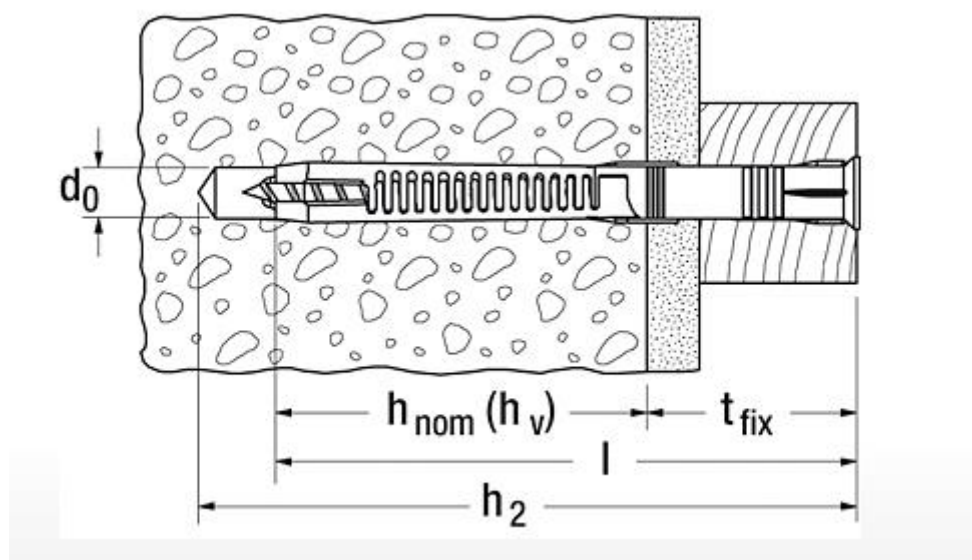

Drill hole diameter	$d_0$	10	[mm]
Anchor length	$l$	80	[mm]
Min. drill hole depth	$h_1$	90	[mm]
Min. drill hole depth for through fixings	$h_2$	90	[mm]
Min. anchorage depth	$h_{nom} (h_v)$	70	[mm]
Max. fixture thickness	$t_{fix}$	10	[mm]
Drive		SW13	
fischer safety screw	$d_s \times l_s$	7 x 85	[mm]
Card contents		4 x FUR 10 x 80 SS, 4 x safety screw 7 x 85 SW13, pre-assembled	
Sales unit		10	[pcs]
GTIN (EAN Code)		8590369454702	